



SIBOARD NF distribution boards (NF technology)

Quick selection guide	1/2
SIBOARD NF distribution boards (NF technology)	1/2
SIBOARD NF system overview	1/6
SIBOARD 800 NF floor-mounted distribution boards	1/8
SIBOARD 630 NF wall-mounted distribution boards	1/10
SIBOARD 630 NF floor-mounted distribution boards	1/12
SIBOARD 125 NF distribution boards	1/16
Assembly kits	1/18
Busbars	1/24
Accessories	1/28

SIBOARD NF distribution boards (NF technology)

1



SIBOARD 800 NF

Basic data

Rated current	A	800
Overvoltage category		III
Rated impulse withstand voltage U_{imp}	kV	6
Rated insulation voltage U_i	V	690
Rated operational voltage U_e	V AC	690
Rated peak withstand current I_{pk}	kA	74
Rated short-time current I_{cw} (1 s)	kA	35
Degree of protection according to IEC 60529/EN 60529		IP30/IP54
Safety class		I
Color		RAL 7035 (light gray)

Dimensions

Height	mm	2000
Width	mm	300/600/900
Depth	mm	400
Steel thickness (enclosure)	mm	1.5

Standards and specifications

DIN		DIN EN 61439-1/-2
IEC		IEC 61439-1/-2
Operating personnel	Electrically skilled person	■
Approvals		VDE

Equipment

Form of internal separation		1
Tested for resistance to internal arcing acc. to EN 61439-2 Supplement 1		–
Active protection against internal arcing		–
Reactive power compensation		–

Other

Type of installation (only indoor)		Floor standing
Type of delivery	Pre-assembled without copper	–
	Pre-assembled with copper	–

More information

[See page 1/6](#)

**SIBOARD 630 NF****SIBOARD 125 NF**

630	125
III	III
6	6
690	400
690	400
53	10
25	17
IP30/IP54	IP30/IP31D/IP43
I	I
RAL 7035 (light gray)	RAL 7035 (light gray)
400/600/800/1000/1200/2000	400/600/800/1000/1200
600 + 250/900	600
250	140
1.5	1.5
DIN EN 61439-1/-2	DIN EN 61439-1/-3
–	–
■	■
VDE	VDE
1	1
–	–
–	–
–	–
Wall	Wall/flush
–	–
–	–
See page 1/10	See page 1/16

Applications

1

Power Center

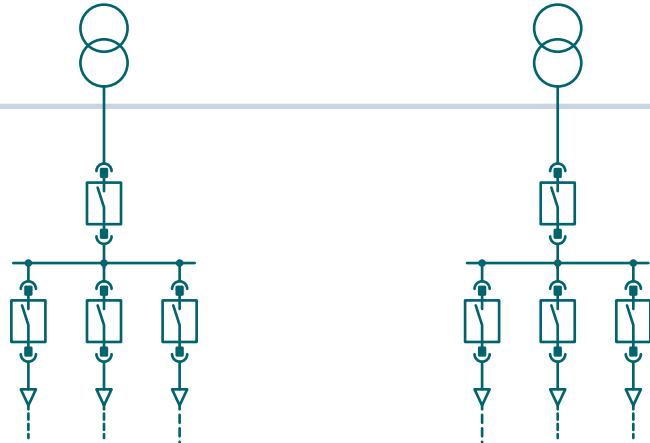

Main distribution boards

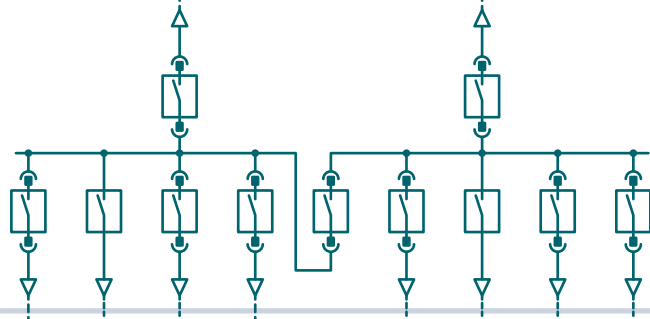

Subdistribution boards

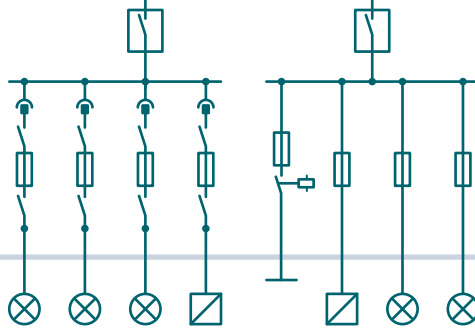

Loads



SIVACON S8



SIVACON S8



SIVACON S4



SIBOARD NF (NF technology)



SIBOARD NF system overview

Distribution boards, assembly kits and accessories

1

SIBOARD NF 800



SIBOARD NF 630



Unequipped distribution boards



SIBOARD 800



SIBOARD 630



SIBOARD 125

Assembly kits



For molded case circuit breakers

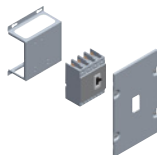

For switch disconnectors



For fuse switch disconnectors



For modular installation devices



For front cover with cutout

Note:

You will find a detailed range of accessories with the basic units and in the Accessories section.

SIBOARD NF 125



Busbars



Cu busbars



Busbar supports

Accessories



Bases



Crossbars

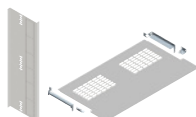

Partitions



Front covers



Locking systems

Note:

You will find a detailed range of accessories with the basic units and in the Accessories section.

SIBOARD 800 NF floor-mounted distribution boards

Rated current 800 A

Unequipped distribution boards

Degree of protection IP30/IP54



Height Outside	Inside	Depth Outside	Width Outside	Inside	Safety class I
2050 mm	2000 mm	400 mm	350 mm	300 mm	8GK2420-7CH14
			650 mm	600 mm	8GK2420-7CH24
			950 mm	900 mm	8GK2420-7CH34

Accessories

Unequipped distribution boards

Sheet-steel doors

Types	Width	Cubicle height	Cubicle width	Article No.
Standard	-	2000 mm	300 mm	8GK9515-8CH12
			600 mm	8GK9515-8CH22
			900 mm	8GK9515-8CH32
For cable compartment	250 mm	2000 mm	900 mm	8GK9515-8CH42

Transparent doors

Types	Cubicle height	Cubicle width	Article No.
Standard	2000 mm	300 mm	8GK9505-8CH10
		600 mm	8GK9505-8CH22
		900 mm	8GK9505-8CH32
Giugiaro design	2000 mm	600 mm	8GK9507-8CH22
		900 mm	8GK9507-8CH32

Double doors

Types	Width	Cubicle height	Cubicle width	Article No.
Made of sheet steel	600 + 250 mm	2000 mm	900 mm	8GK9515-8CH22 + 8GK9515-8CH42
Transparent door + sheet-steel door	600 + 250 mm	2000 mm	900 mm	8GK9505-8CH22 + 8GK9515-8CH42
Transparent door in Giugiaro design + sheet-steel door	600 + 250 mm	2000 mm	900 mm	8GK9507-8CH22 + 8GK9515-8CH42

Accessories

Unequipped
distribution boards

Vertical profile bars for compartment/busbars



Cubicle height	Cubicle width	Article No.
2000 mm	300/600/900 mm	8GK9200-8CH01

Front covers for cabling compartment



Height	Width	Cubicle height	Cubicle width	Article No.
1000 + 1000 mm	250/300 mm	2000 mm	300 mm	8GK9607-7CH10 + 8GK9607-7CH10
			900 mm	8GK9606-7CH10 + 8GK9606-7CH10

Bases

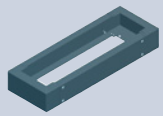

Color	Height	Cubicle height	Cubicle width	Article No.
Grey	100 mm	2000 mm	300 mm	8GK9906-0CH15
			600 mm	8GK9906-0CH25
			900 mm	8GK9906-0CH35

Side panels



Color	Cubicle height	Cubicle width	Article No.
RAL 7035 (pair)	2000 mm	300/600/900 mm	8GK9200-8CH05

Supports



Types	Height	Article No.
Mounting stays (pair)	1800 mm	8GK6850-0CH03
	2000 mm	8GK6850-0CH04
Rear NF supports	2000 mm	8GK6850-0CH06

Crossbars

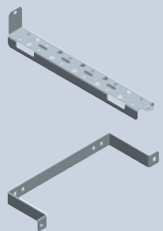

Types	Article No.
Upper crossbar	8GK6850-0CH00
Lateral crossbar	8GK6850-0CH01

Adapter for installation of assembly kits in the cabling compartment, width 250 mm (2 units)	8GK9920-0CH01
--	---------------

SIBOARD 630 NF wall-mounted distribution boards

Rated current 630 A

Unequipped distribution board without door

Degree of protection IP30/IP54



Height Outside	Height Inside	Depth Outside	Width Outside	Width Inside	Safety class I
450 mm	400 mm	250 mm	650 mm	600 mm	8GK2124-0CH23
650 mm	600 mm	250 mm	650 mm	600 mm	8GK2124-1CH23
850 mm	800 mm	250 mm	650 mm	600 mm	8GK2124-2CH23
1050 mm	1000 mm	250 mm	650 mm	600 mm	8GK2124-3CH23
			950 mm	900 mm	8GK2124-3CH33
1250 mm	1200 mm	250 mm	650 mm	600 mm	8GK2124-4CH23
			950 mm	900 mm	8GK2124-4CH33

Accessories

Doors

Sheet-steel doors







Types	Cubicle height	Cubicle width	Article No.
Standard	400 mm	600 mm	8GK9515-3CH20
	600 mm	600 mm	8GK9515-4CH20
	800 mm	600 mm	8GK9515-5CH20
	1000 mm	600 mm	8GK9515-6CH20
		900 mm	8GK9515-6CH30
	1200 mm	600 mm	8GK9515-7CH20
For cable compartment	1000 mm	900 mm	8GK9515-7CH30
		900 mm	8GK9515-7CH40
	1200 mm	900 mm	8GK9515-7CH40
		600 + 300 mm	-

Transparent doors



Types	Cubicle height	Cubicle width	Article No.
Standard	400 mm	600 mm	8GK9505-3CH20
	600 mm	600 mm	8GK9505-4CH20
	800 mm	600 mm	8GK9505-5CH20
	1000 mm	600 mm	8GK9505-6CH20
		900 mm	8GK9505-6CH30
	1200 mm	600 mm	8GK9505-7CH20
Giugiaro design	400 mm	600 mm	8GK9507-2CH23
		900 mm	8GK9505-7CH30
	600 mm	600 mm	8GK9507-4CH23
		900 mm	8GK9507-4CH33
	800 mm	600 mm	8GK9507-5CH23
		900 mm	8GK9507-5CH33
	1000 mm	600 mm	8GK9507-7CH23
900 mm		8GK9507-7CH33	
1200 mm	600 mm	8GK9507-8CH23	
	900 mm	8GK9507-8CH33	

Accessories

Double doors					Doors
Types	Width	Cubicle height	Cubicle width	Article No.	
 Made of sheet steel	600 + 250 mm ¹⁾	1000 mm	900 mm	8GK9515-6CH20 + 8GK9515-6CH40	
		1200 mm	900 mm	8GK9515-7CH20 + 8GK9515-7CH40	
 Transparent door + sheet-steel door	600 + 250 mm	1000 mm	900 mm	8GK9505-6CH20 + 8GK9515-6CH40	
		1200 mm	900 mm	8GK9505-7CH20 + 8GK9515-7CH40	
 Transparent door in Giugiaro design + sheet-steel door	600 + 250 mm ¹⁾	1600 mm	900 mm	8GK9507-7CH23 + 8GK9515-6CH40	
		1800 mm	900 mm	8GK9507-8CH23 + 8GK9515-7CH40	
Vertical profile bars for cabling compartment					
		Cubicle height	Cubicle width	Article No.	
		1000 mm	900 mm	8GK9125-7CH01	
		1200 mm	900 mm	8GK9127-8CH01	
Front covers for cabling compartment					
	Height	Width	Cubicle height	Cubicle width	Article No.
	1000 mm	250/300 mm	1000 mm	900 mm	8GK9606-7CH10
	600 + 600 mm	250/300 mm	1200 mm	900 mm	8GK9606-4CH10 + 8GK9606-4CH10

¹⁾ For distribution boards with a width of 900 mm with double door and vertical profile bar

SIBOARD 630 NF floor-mounted distribution boards

Rated current 630 A

1

Unequipped
distribution boards

Degree of protection IP30/IP54



Height		Depth Outside	Width		Safety class I
Outside	Inside		Outside	Inside	
2050 mm	2000 mm	250 mm	350 mm	300 mm	8GK2325-7CH13
			650 mm	600 mm	8GK2325-7CH23
			950 mm	900 mm	8GK2325-7CH43

SIBOARD 630 NF floor-mounted distribution boards

Rated current 630 A

Accessories

Unequipped distribution boards

Sheet-steel doors

Types	Width	Cubicle height	Cubicle width	Article No.
Standard	–	2000 mm	300 mm	8GK9515-8CH12
			600 mm	8GK9515-8CH22
			900 mm	8GK9515-8CH32
For cable compartment	250 mm	2000 mm	900 mm	8GK9515-8CH42

Transparent doors

Types	Cubicle height	Cubicle width	Article No.
Standard	2000 mm	300 mm	8GK9505-8CH10
		600 mm	8GK9505-8CH22
		900 mm	8GK9505-8CH32
Giugiaro design	2000 mm	600 mm	8GK9507-8CH22
		900 mm	8GK9507-8CH32

Double doors

Types	Width	Cubicle height	Cubicle width	Article No.
Made of sheet steel	600 + 250 mm	2000 mm	900 mm	8GK9515-8CH22 + 8GK9515-8CH42
Transparent door + sheet-steel door	600 + 250 mm	2000 mm	900 mm	8GK9505-8CH22 + 8GK9515-8CH42
Transparent door in Giugiaro design + sheet-steel door	600 + 250 mm	2000 mm	900 mm	8GK9507-8CH22 + 8GK9515-8CH42

Vertical profile bars for cabling compartment

Cubicle height	Cubicle width	Article No.
2000 mm	900 mm	8GK9125-8CH13

Accessories

Unequipped
distribution boards

Front covers for cabling compartment

Height	Width	Cubicle height	Cubicle width	Article No.
1000 + 1000 mm	250/300 mm	2000 mm	300 mm	8GK9607-7CH10 + 8GK9607-7CH10
			900 mm	8GK9606-7CH10 + 8GK9606-7CH10

Covers for cable entry and cable duct

Cubicle height	Cubicle width	Article No.
2000 mm	300 mm	8GK9920-0CH40
2000 mm	600 mm	8GK9920-0CH41
2000 mm	900 mm	8GK9920-0CH42





Side panels

Color	Cubicle height	Cubicle width	Article No.
RAL 7035 (pair)	2000 mm	300/600/900 mm	8GK9122-8CH05

SIBOARD NF 125 distribution boards

Rated current 125 A

1

						Surface-mounting distribution boards		Flush-mounting distribution boards	
						With sheet-steel door	With transparent door	With sheet-steel door	With transparent door
Degree of protection						IP43	IP43	IP31D	IP31D
									
Height Outside	Height Inside	Depth Outside	Width Outside	Width Inside	Tiers (MW = 18 mm)	Safety class I	Safety class I	Safety class I	Safety class I
450 mm	400 mm	140 mm	660 mm	600 mm	48 (2× 24)	8GK2042-0CH21	8GK2042-0CG21	–	–
650 mm	600 mm	140 mm	660 mm	600 mm	72 (3× 24)	8GK2042-1CH21	8GK2042-1CG21	–	–
800 mm	850 mm	140 mm	660 mm	600 mm	96 (4× 24)	8GK2042-2CH21	8GK2042-2CG21	–	–
1050 mm	1000 mm	140 mm	660 mm	600 mm	120 (5× 24)	8GK2042-3CH21	8GK2042-3CG21	–	–
1250 mm	1200 mm	140 mm	660 mm	600 mm	144 (6× 24)	8GK2042-4CH21	8GK2042-4CG21	–	–
511 mm	400 mm	140 mm	722 mm	600 mm	48 (2× 24)	–	–	8GK2043-0CH21	8GK2043-0CG21
711 mm	600 mm	140 mm	722 mm	600 mm	72 (3× 24)	–	–	8GK2043-1CH21	8GK2043-1CG21
911 mm	800 mm	140 mm	722 mm	600 mm	96 (4× 24)	–	–	8GK2043-2CH21	8GK2043-2CG21
1111 mm	1000 mm	140 mm	722 mm	600 mm	120 (5× 24)	–	–	8GK2043-3CH21	8GK2043-3CG21
1311 mm	1200 mm	140 mm	722 mm	600 mm	144 (6× 24)	–	–	8GK2043-4CH21	8GK2043-4CG21

Accessories

Front covers

- With quick-lock screws and integrated grounding connection

Type	Height	Width	Article No.
Closed	50 mm	600 mm	8GK9620-1CH20
	100 mm	600 mm	8GK9621-1CH20
	150 mm	600 mm	8GK9622-1CH20
	200 mm	600 mm	8GK9623-1CH20
	400 mm	600 mm	8GK9622-2CH20
	600 mm	600 mm	8GK9622-4CH20
	800 mm	600 mm	8GK9622-5CH20
For modular installation devices	150 mm	600 mm	8GK9608-1CH22
	200 mm	600 mm	8GK9608-1CH20
	300 mm	600 mm	8GK9608-2CH22
	400 mm	600 mm	8GK9608-2CH20
	450 mm	600 mm	8GK9608-3CH22
600 mm	600 mm	8GK9608-4CH20	

Standard mounting rails for modular installation devices

Width	Article No.
600 mm	8GK9920-0CH11

Holders for cable duct

Width	Article No.
600 mm	8GK9920-0CH20

Hinges for covers



Version	Article No.
For hinged covers	8GK9120-0KK11

Hinges for covers

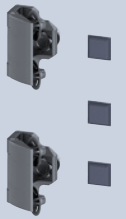

Version	Scope of supply	Article No.
Hinge, incl. fixing accessories	1 set	8PQ2000-0BA08

Rotary handles



Version	Color	Article No.
Plastic	Black	8GK9560-0CH04
	Black (10 parts)	8GK9560-1CH04

Assembly kits

For 3VA molded case circuit breakers

1



Switches/breakers				Distribution board		With RCD module	Without RCD module
Type	Rated current	Quantity	Rotary operating mechanism	Height outside	Width outside	Infeed side	
3VA10.. and 3VA11..	100 A/160 A	1	–	200 mm	600 mm	8GK6735-2CH23	8GK6730-2CH23
			■	200 mm	600 mm	8GK6735-2CH33	8GK6730-2CH33
			■	200 mm	900 mm	–	8GK6733-2CH23
3VA12..	250 A	1	–	200 mm	600 mm	8GK6736-2CH23	8GK6721-2CH23
			■	200 mm	600 mm	8GK6736-2CH33	8GK6721-2CH33
			■	200 mm	900 mm	–	8GK6734-2CH23
3VA20.. and 3VA22..	100 A/250 A	1	–	200 mm	600 mm	8GK6725-2CH23	8GK6720-2CH23
			■	200 mm	600 mm	8GK6725-2CH33	8GK6720-2CH33
			■	200 mm	900 mm	–	8GK6723-2CH23
3VA23.. and 3VA24..	400 A/630 A	1	–	400 mm	600 mm	–	8GK6740-4CH23
			■	400 mm	900 mm	8GK6745-4CH23	8GK6740-4CH33

Vertical

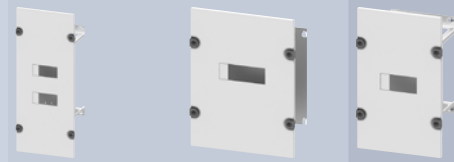

Switches/breakers		Quantity	Motorized operating mechanism	Distribution board		With RCD module		Without RCD module				
Type	Rated current			Height outside	Width outside	Infeed side	At side					
3VA10.. and 3VA11..	100 A/160 A	1	-	-	200 mm	300 mm	-	-	8GK6731-2CH13			
					400 mm	250 mm	-	-	8GK6730-4CH43			
					300 mm	-	8GK6731-6CH13	8GK6730-4CH13				
				■	600 mm	250 mm	8GK6735-4CH43	-	-			
					300 mm	8GK6735-6CH13	-	-				
					400 mm	300 mm	-	8GK6738-6CH13	8GK6734-4CH13			
		3	-	-	-	600 mm	300 mm	8GK6736-6CH13	-	-		
						200 mm	600 mm	-	-	8GK6731-2CH23		
				■	400 mm	600 mm	-	8GK6731-6CH23	8GK6730-4CH23			
					900 mm	-	-	8GK6731-6CH33				
					600 mm	600 mm	8GK6735-6CH23	-	-			
					200 mm	600 mm	-	-	8GK6734-4CH23			
				5	-	-	-	400 mm	600 mm	-	8GK6737-6CH23	-
								900 mm	-	8GK6737-6CH33	-	
								600 mm	600 mm	8GK6736-6CH23	-	-
								200 mm	900 mm	-	-	8GK6731-2CH33
■	400 mm	900 mm	-	-	8GK6730-4CH33							
	200 mm	900 mm	-	-	8GK6734-4CH33							
	600 mm	900 mm	8GK6736-6CH33	-	-							
	400 mm	900 mm	-	-	8GK6721-4CH33							
3VA12..	250 A	1	-	-	400 mm	300 mm	-	-	8GK6721-4CH13			
					600 mm	250 mm	8GK6732-6CH13	-	8GK6730-6CH13			
					300 mm	-	8GK6722-6CH13	8GK6721-6CH13				
				■	400 mm	600 mm	-	-	8GK6721-4CH23			
					600 mm	600 mm	-	8GK6724-6CH23	8GK6721-6CH23			
					400 mm	600 mm	-	-	8GK6722-6CH23			
		5	-	-	-	600 mm	600 mm	-	8GK6723-6CH23	-		
						400 mm	900 mm	-	-	8GK6721-4CH33		
						600 mm	900 mm	-	8GK6724-6CH33	8GK6721-6CH33		
						■	400 mm	900 mm	-	-	8GK6722-6CH33	
							600 mm	900 mm	-	8GK6723-6CH33	-	
						3VA20.. and 3VA22..	100 A/250 A	1	-	-	400 mm	300 mm
600 mm	300 mm	8GK6725-6CH13	-	-								
3	-	400 mm	600 mm	-	-						8GK6720-4CH23	
600 mm		600 mm	8GK6725-6CH23	-	-							
■	400 mm	600 mm	-	-	8GK6724-4CH23							
	5	-	400 mm	900 mm	-			-	8GK6720-4CH33			
	600 mm		900 mm	8GK6725-6CH33	-	-						
■	400 mm	900 mm	-	-	8GK6724-4CH33							
	3VA23.. and 3VA24..	400 A/630 A	1	-	600 mm	300 mm	-	-	8GK6740-6CH13			
					2	600 mm	600 mm	8GK6745-6CH23	-	8GK6740-6CH23		
3					600 mm	900 mm	8GK6745-6CH33	-	8GK6740-6CH33			

Assembly kits

For 3KF switch disconnectors with fuses

1

Vertical



Switches/breakers				Distribution board			
Type	Rated current	Operating mechanism in center	Door-coupling rotary operating mechanism	Height	Width	Depth	
2× 3KF1	80 A	■	–	200 mm	600 mm	250 mm	8GK6431-2CH23
					900 mm	250 mm	8GK6431-2CH33
2× 3KF2	160 A	■	–	200 mm	600 mm	250 mm	8GK6432-2CH23
					900 mm	250 mm	8GK6432-2CH33
2× 3KF1/3KF2 or 1× 3KF3/3KF4	400 A	–	■	400 mm	600 mm	400 mm	8GK6431-4CH33
					900 mm	400 mm	8GK6432-4CH33

For 3KD switch disconnectors

Vertical



Switches/breakers				Distribution board		
Size	Rated current	Quantity	Door-coupling rotary operating mechanism	Height outside	Width outside	
1/2/3	63 A/250 A/400 A	1/1	■	400 mm	250 mm	8GK6430-4CH13
1/2/3/4	63 A/250 A/400 A/630 A	2/1	■	400 mm	600 mm	8GK6430-4CH23
1/2/3/4	63 A/250 A/400 A/630 A	2	■	400 mm	900 mm	8GK6430-4CH33

For modular installation devices

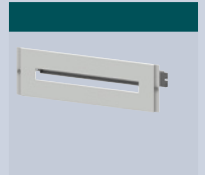

1

Switches/breakers		Distribution board		
No. of tiers	MW	Height outside	Width outside	
1	12	200 mm	300 mm	8GK6352-2CH13
	24	150 mm	600 mm	8GK6302-1CH23
		200 mm	600 mm	8GK6352-2CH23
	36	150 mm	900 mm	8GK6302-1CH33
		200 mm	900 mm	8GK6352-2CH33

Accessories

Standard mounting rails

Version	Width	No. of tiers	Article No.
For mounting modular devices at various depths	600 mm	1	8GK9680-0CH00
	900 mm	1	8GK9680-0CH01



Depth adapters 9 mm

Version	Width	No. of tiers	MW	Article No.
For linking 5SY and 5SJ on standard mounting rails, L 360 mm	600 mm	1	20	8GF9670-1

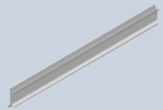

Assembly kits

For front cover with cutout

1

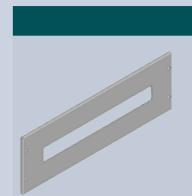

Switches/breakers No. of tiers	MW	Distribution board		
		Height outside	Width outside	
1	24	150 mm	600 mm	8GK9608-1CH22
	24	200 mm	600 mm	8GK9608-1CH20
	36	150 mm	900 mm	8GK9608-1CH32
		200 mm	900 mm	8GK9608-1CH30
2	48	300 mm	600 mm	8GK9608-2CH22
		400 mm	600 mm	8GK9608-2CH20
	72	300 mm	900 mm	8GK9608-2CH32
		400 mm	900 mm	8GK9608-2CH30
		450 mm	600 mm	8GK9608-3CH22
	108	600 mm	600 mm	8GK9608-4CH20
		600 mm	900 mm	8GK9608-4CH30

Accessories

Standard mounting rails



Version	Width	No. of tiers	Article No.
For mounting modular devices at various depths	600 mm	1	8GK9680-0CH00
	900 mm	1	8GK9680-0CH01

Depth adapters 9 mm

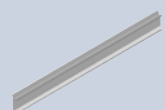

Version	Width	No. of tiers	MW	Article No.
For linking 5SY and 5SJ on standard mounting rails, L 360 mm	600 mm	1	20	8GF9670-1

Busbars

For SIBOARD 800/630 NF distribution boards

1

Vertical installation of rear busbars (single bars only)

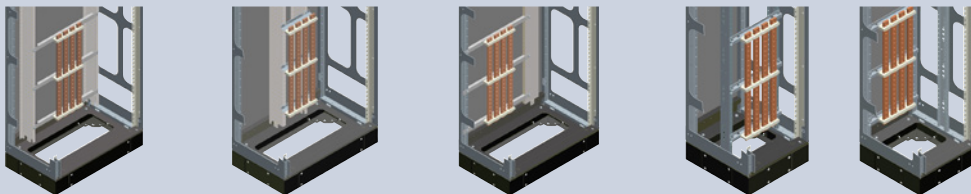

Version	Width 600/900 mm	For a spacing of 150 mm, width 600/900 mm	Recessed, width 600/900 mm	Width 300 mm	Recessed, width 300 mm
Busbar supports:	8GK5760-0CH04/-0CH05 (width 600 mm) 8GK5760-0CH06/-0CH07 (width 900 mm)	8GK5760-0CH02/-0CH03	8GK5760-0CH04/-0CH05 (width 600 mm) 8GK5760-0CH06/-0CH07 (width 900 mm)	8GK5760-0CH08/-0CH10	8GK5760-0CH08/-0CH10
Supplements: Rear NF supports	8GK6850-0CH05/06 (2 units)	8GK6850-0CH05/06 (2 units)	8GK6850-0CH05/06 (1 unit)	–	–

Horizontal busbars (single bars only)

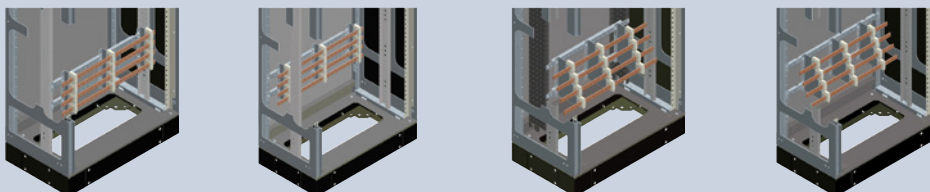

Version	Front	Recessed	Front, with steps	Recessed, with steps
Busbar supports:	8GK5760-0CH02/-0CH03	8GK5760-0CH02/-0CH03	8GK5760-0CH00/-0CH01	8GK5760-0CH00/-0CH01
Supplements: Support plate	8GK9672-0CH04 (width 600 mm) 8GK9672-0CH05 (width 900 mm)	8GK9672-0CH04 (width 600 mm) 8GK9672-0CH05 (width 900 mm)	8GK9920-0CH35 (width 600 mm) 8GK9920-0CH36 (width 900 mm)	8GK9672-0CH04 (width 600 mm) 8GK9672-0CH05 (width 900 mm)
Rear NF supports	–	–	8GK6850-0CH05/06 (2 units)	–

For SIBOARD 800 NF distribution boards

Horizontal busbars at top (double bars only)

1

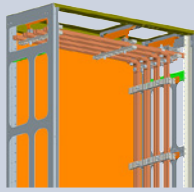

Version		
Busbar supports	With support plate	8GK9750-0CH02
Supplements		If there is no support 8GK9750-0CH02 mounted onto the side of the cabling compartment, you will need to order an upper crossbar 8GK6850-0CH00.

Vertical busbars, for sides

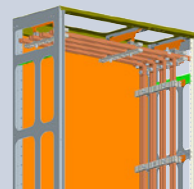
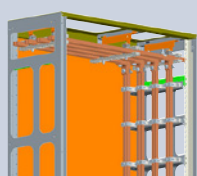

Version		Double busbar with steps	Single busbar with steps	Double busbar	Busbar
Busbar supports:		8GK9750-0CH01	8GK5760-0CH00/-0CH01	8GK9750-0CH02	8GK5760-0CH02/-0CH03
Supplements	Lateral crossbar	8GK6850-0CH01	8GK6850-0CH01	8GK6850-0CH01	8GK6850-0CH01

Busbars

1

Busbar supports

SIBOARD 630

SIBOARD 800

Vertical, at side/horizontal, at front, graded

Busbar cross-section	Width	Number of poles	Busbar center-to-center spacing	Article No.	Article No.
15/20/30 × 5	600/900 mm	4-pole	50 mm	8GK5760-0CH00	8GK5760-0CH00
30 × 10	600/900 mm	4-pole	50 mm	8GK5760-0CH01	8GK5760-0CH01
15/20/30 × 10	600/900 mm	4-pole	50 mm	–	8GK9750-0CH01
20/30 × 10	600/900 mm	4-pole	50 mm	–	8GK9750-0CH02



Vertical

Busbar cross-section	Width	Number of poles	Busbar center-to-center spacing	Article No.	Article No.
15/20/30 × 5	300 mm	4-pole	50 mm	8GK5760-0CH08	8GK5760-0CH08
30 × 10	300 mm	4-pole	50 mm	8GK5760-0CH10	8GK5760-0CH10

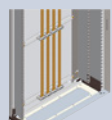

Vertical, at rear

Busbar cross-section	Width	Number of poles	Busbar center-to-center spacing	Article No.	Article No.
15/20/30 × 5	600 mm	4-pole	50 mm	8GK5760-0CH04	8GK5760-0CH04
	900 mm	4-pole	50 mm	8GK5760-0CH06	8GK5760-0CH06
30 × 10	600 mm	4-pole	50 mm	8GK5760-0CH05	8GK5760-0CH05
	900 mm	4-pole	50 mm	8GK5760-0CH07	8GK5760-0CH07

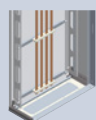

Horizontal, at front¹⁾

Busbar cross-section	Width	Number of poles	Busbar center-to-center spacing	Article No.	Article No.
15/20/30 × 5	300/600/900 mm	4-pole	50 mm	8GK5760-0CH02	8GK5760-0CH02
30 × 10	300/600/900 mm	4-pole	50 mm	8GK5760-0CH03	8GK5760-0CH03
	600/900 mm	4-pole	50 mm	–	8GK9608-1CH22

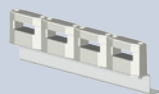



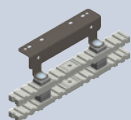

Horizontal, at top

Busbar cross-section	Width	Number of poles	Busbar center-to-center spacing	Article No.	Article No.
20/30 × 10	600/900 mm	4-pole	50 mm	–	8GK9750-0CH02
					8PQ4000-1BA12

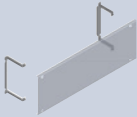

¹⁾ Can be mounted directly on equipment racks with a clearance of 525 mm (width 600 mm) and 825 mm (width 900 mm).

Other accessories

				SIBOARD 630	SIBOARD 800
Set of screws/bolts for slotted bars					
	Cross-section	Outer thread	Tightening torque	Article No.	Article No.
	15/20/30 × 5	M6	8 Nm	8GF5891	8GF5891
	30 × 10	M8	20 Nm	8GF5892	8GF5892
Crossbars for installation of support					
	Version	Width		Article No.	Article No.
	For 8GK5760-0CH02, 8GK5760-0CH00, 8GK5760-0CH03, 8GK9608-1CH22	600 mm		8GK9672-0CH04	8GK9672-0CH04
		900 mm		8GK9672-0CH05	8GK9672-0CH05
	For 8GK5760-0CH00	600 mm		8GK9920-0CH35	8GK9920-0CH35
		900 mm		8GK9920-0CH36	8GK9920-0CH36
	For 8GK9750-0CH02	400 mm		–	8GK6850-0CH00
	For 8GK5760-0CH00, 8GK5760-0CH08, 8GK5760-0CH01, 8GK5760-0CH10, 8GK9750-0CH01, 8GK9750-0CH02	400 mm		–	8GK6850-0CH01
Transparent cover					
	Version	Width		Article No.	Article No.
	For horizontal busbars, at front	600 mm		8GK9920-0CH37	8GK9920-0CH37
		900 mm		8GK9920-0CH38	8GK9920-0CH38
Connecting kit for double bars					
	Version	Current		Article No.	Article No.
	Connecting kit for upper horizontal bars – vertical busbars	800 A		–	8GK9790-0KK00
	Connecting kit for upper horizontal busbars	800 A		–	8GK9790-0KK01
Holder for grounding bar					
				Article No.	Article No.
				–	8GK9750-0KK00

Accessories

1

Covers and holders

125 630 800

Covers for mounting measuring instruments



Measuring devices	Type	Height	Width	Article No.	125	630	800
72 x 72	2 instruments + 2 selectors	200 mm	600 mm	8GK9610-1CH20	■	■	■
			900 mm	8GK9610-1CH30	■	■	■
	4 instruments + 1 selector	200 mm	600 mm	8GK9611-1CH20	■	■	■
			900 mm	8GK9611-1CH30	■	■	■
96 x 96	2 instruments + 2 selectors	200 mm	600 mm	8GK9612-1CH20	■	■	■
			900 mm	8GK9612-1CH30	■	■	■
	4 instruments + 1 selector	200 mm	600 mm	8GK9613-1CH20	■	■	■
			900 mm	8GK9613-1CH30	■	■	■

Covers for pushbuttons and indicator lights

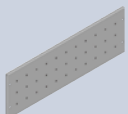

Height	Width	Article No.	125	630	800
200 mm	600 mm	8GK9630-1CH20	■	■	■
	900 mm	8GK9631-1CH20	■	■	■

Non-transparent covers



Height	Width	Article No.	125	630	800
50 mm	600 mm	8GK9620-1CH20	■	■	■
	900 mm	8GK9620-1CH30	■	■	■
100 mm	600 mm	8GK9621-1CH20	■	■	■
	900 mm	8GK9621-1CH30	■	■	■
150 mm	600 mm	8GK9622-1CH20	■	■	■
	900 mm	8GK9622-1CH30	■	■	■
200 mm	300 mm	8GK9607-1CH10	■	■	■
	600 mm	8GK9623-1CH20	■	■	■
	900 mm	8GK9623-1CH30	■	■	■
	900 mm	8GK9622-2CH30	■	■	■
400 mm	250 mm	8GK9606-2CH10	■	■	■
	300 mm	8GK9607-2CH10	■	■	■
	600 mm	8GK9622-2CH20	■	■	■
	900 mm	8GK9622-2CH30	■	■	■
600 mm	250 mm	8GK9606-4CH10	■	■	■
	300 mm	8GK9607-4CH10	■	■	■
	600 mm	8GK9622-4CH20	■	■	■
	900 mm	8GK9622-4CH30	■	■	■
800 mm	250 mm	8GK9606-5CH10	■	■	■
	300 mm	8GK9607-5CH10	■	■	■
	600 mm	8GK9622-5CH20	■	■	■
	900 mm	8GK9622-5CH30	■	■	■
1000 mm	250 mm	8GK9606-7CH10	■	■	■
	300 mm	8GK9607-7CH10	■	■	■

Deep-drawn covers 25 mm

Height	Width	Article No.	125	630	800
800 mm	600 mm	8GK9635-5CH20	■	■	■
	900 mm	8GK9635-5CH30	■	■	■
1000 mm	600 mm	8GK9636-7CH20	■	■	■
	900 mm	8GK9636-7CH30	■	■	■

Deep-drawn front covers 35 mm

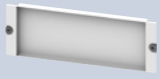

Height	Width	Article No.	125	630	800
200 mm	600 mm	8GK9605-1CH20	■	■	■
	900 mm	8GK9605-1CH30	■	■	■
400 mm	600 mm	8GK9605-2CH20	■	■	■
	900 mm	8GK9605-2CH30	■	■	■
600 mm	600 mm	8GK9605-4CH20	■	■	■
	900 mm	8GK9605-4CH30	■	■	■

Covers and holders

125 630 800

Covers with ventilation openings IP30

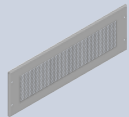

Height	Width	Article No.	125	630	800
200 mm	600 mm	8GK9632-1CH20	■	■	■
	900 mm	8GK9633-1CH20	■	■	■

Holders for horizontal cable ducts/horizontal busbars (pair)



Width	Article No.	125	630	800
600 mm	8GK9672-0CH04	■	■	■
900 mm	8GK9672-0CH05	■	■	■

Horizontal crossbars with steps (pair)



Width	Article No.	125	630	800
600 mm	8GK9920-0CH35	■	■	■
900 mm	8GK9920-0CH36	■	■	■

Support rails (pair)

- SIBOARD 630 NF vertical/horizontal busbar support, with steps
- Vertical side terminal strip (not suitable for use in SIBOARD 800 NF)



Height	Article No.	125	630	800
1000 mm	8GK9672-0CH06	■	■	■
1200 mm	8GK9672-0CH07	■	■	■
2000 mm	8GK9672-0CH08	■	■	■

Inner supports

- For using cubicle B 300 as a switchgear compartment in SIBOARD 630 NF (not suitable for use in SIBOARD 800 NF)



Height	Article No.	125	630	800
2000 mm	8GK9126-8CH05	■	■	■

Accessories

1

Mounting plates and inner subdivisions

125 630 800

Modular mounting plates

- SIBOARD 800 NF: for mounting on side supports or on the base of the cabinet



Height	Width	Article No.	125	630	800
200 mm	600 mm	8GK9540-2CH20	■	■	■
	900 mm	8GK9540-2CH30	■	■	■
400 mm	600 mm	8GK9540-3CH20	■	■	■
	900 mm	8GK9540-3CH30	■	■	■
600 mm	600 mm	8GK9540-4CH20	■	■	■
	900 mm	8GK9540-4CH30	■	■	■

Recessed modular mounting plates

- SIBOARD 800 NF: for mounting on two rear supports or on the rear panel of the cabinet with one rear support



Height	Width	Article No.	125	630	800
200 mm	600 mm	8GK9540-2CH21	■	■	■
	900 mm	8GK9540-2CH31	■	■	■
400 mm	600 mm	8GK9540-3CH21	■	■	■
	900 mm	8GK9540-3CH31	■	■	■
600 mm	600 mm	8GK9540-4CH21	■	■	■
	900 mm	8GK9540-4CH31	■	■	■

2 mm mounting plates for electrotechnical use with height and width of the cabinet

- SIBOARD 800 NF: Plates that are not as high as the cabinet can be mounted using side supports and holders 8GK9672-0CH04/-0CH05



Height	Width	Article No.	125	630	800
600 mm	600 mm	8GK9535-4CH21	■	■	■
800 mm	600 mm	8GK9535-5CH21	■	■	■
1000 mm	600 mm	8GK9536-7CH21	■	■	■
	900 mm	8GK9536-7CH31	■	■	■
1200 mm	600 mm	8GK9537-8CH21	■	■	■
	900 mm	8GK9537-8CH31	■	■	■
1600 mm	600 mm	8GK9535-8CH23	■	■	■
	900 mm	8GK9535-8CH26	■	■	■
1800 mm	600 mm	8GK9535-8CH24	■	■	■
	900 mm	8GK9535-8CH34	■	■	■
2000 mm	600 mm	8GK9535-8CH25	■	■	■
	900 mm	8GK9535-8CH35	■	■	■

Partitions for SIBOARD 630 NF





Mounting	Height	Width	Article No.	125	630	800
Horizontal	–	250 mm	8GK9525-0CH03		■	
		300 mm	8GK9525-0CH13		■	
		600 mm	8GK9525-0CH23		■	
		900 mm	8GK9525-0CH33		■	
Vertical	800 mm	–	8GK9525-5CH03		■	
	1000 mm	–	8GK9525-6CH03		■	
	1200 mm	–	8GK9525-7CH03		■	
	2000 mm	–	8GK9525-8CH23		■	

Mounting plates and inner subdivisions

125 630 800

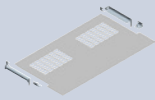
Partitions for SIBOARD 800 NF cabinets in form 2b

Mounting	Height	Width	Article No.	125	630	800
 Horizontal subdivisions between devices	–	300 mm	8GK9526-0CH06			■
		600 mm	8GK9526-0CH07			■
		900 mm	8GK9526-0CH08			■
 Horizontal subdivisions between upper busbar compartment and devices	–	250 mm	8GK9527-0CH05			■
		300 mm	8GK9526-0CH03			■
		600 mm	8GK9526-0CH04			■
		900 mm	8GK9526-0CH05			■
 Vertical subdivisions between the switchgear compartment and busbar compartment	2000 mm	600 mm	8GK9526-0CH02			■

Transparent covers

Width	Article No.	125	630	800
250 mm	8GK9527-0CH03	■	■	■
300 mm	8GK9527-0CH00	■	■	■
600 mm	8GK9527-0CH01	■	■	■
900 mm	8GK9527-0CH02	■	■	■

Accessories

1

Holders for terminal strips and locking systems

125 630 800

Standard mounting rails for terminal blocks



Type	Height	Width	Article No.	125	630	800
Horizontal	–	600 mm	8GK9672-0CH00	■	■	■
		900 mm	8GK9672-0CH02	■	■	■
Horizontal, recessed	–	600 mm	8GK9672-0CH01	■	■	■
		900 mm	8GK9672-0CH03	■	■	■

Holders for standard mounting rails

Version	Scope of supply	Width	Article No.	125	630	800
For mounting the terminal strip vertically in the cabling compartment	4 units	600/900 mm	8GK9920-0CH28	■	■	■

SIBOARD Standard locking devices for wall-mounted distribution boards



Material	Width	Article No.	125	630	800
Made of plastic, black (spare part)	600/900 mm	8GK9560-0CH04	■	■	■

Seals for standard locking devices



Degree of protection	Width	Article No.	125	630	800
IP54	600/900 mm	8GK9560-0CH05	■	■	■

Rotary handle locking mechanism



- For wall-mounted distribution boards, IP43 and IP54, semicylinder insert possible for E012

Width	Article No.	125	630	800
600/900 mm	8GK9560-0CH06	■	■	■

Locking systems for distribution boards



Type	Width	Article No.	125	630	800
Espagnolette lock with pushbutton (spare part)	600/900 mm	8GK9561-0CH01	■	■	■
Insert for profile semicylinder with key	600/900 mm	8GK9561-0CH02	■	■	■

SIBOARD door locking system

Type	Article No.	125	630	800
For floor-mounted boards with double bit incl. SIBOARD key-plate	8GK9800-0CH00			

SIBOARD Locking bars

Type	Height	Article No.	125	630	800
For floor-mounted board	2000 mm	8GK9800-0CH01			
For wall-mounted boards	600 mm	8GK9800-0CH02			
	800 mm	8GK9800-0CH03			
	1000 mm	8GK9800-0CH04			
	1200 mm	8GK9800-0CH05			

Other accessories

				125	630	800	
Flange plates for flat pack delivery (optional)							
	Height		Article No.				
	300 mm		8GK9120-0CH10	■	■	■	
	600 mm		8GK9120-0CH20	■	■	■	
Ventilation grilles – side panels							
	Scope of supply		Article No.				
	4 units		8GK9120-0CH30	■	■	■	
Hinges for front covers							
	Scope of supply		Article No.				
	10 units		8GK9120-0KK11	■	■	■	
Mounting kit for modular distribution boards, IP54 (incl. seal)							
			Article No.				
			8GK9920-0CH31	■	■	■	
Circuit diagram pockets							
	Types	Depth	Article No.				
	DIN A4, transparent sleeve, adhered all-over		10 mm	8GK9910-0KK23	■	■	■
	DIN A4, made of plastic		30 mm	8GD9132	■	■	■
	DIN A4, large pack, made of plastic		30 mm	8GK9910-1KK24	■	■	■
Blanking cover for modular installation devices							
	Version		Article No.				
	For 12 modular widths (1 MW=18 mm)		8GK9910-0CH00	■	■	■	
Cover strips							
	Length		Article No.				
	1 m		8GK9910-0KK01	■	■	■	
Spare brackets for flat pack assembly							
Scope of supply		Article No.					
2 units		8GK9920-0CH26	■	■	■		
Failsafe kit SIBOARD							
<ul style="list-style-type: none"> Self-tapping screws, captive nuts, hinges for covers, covers etc. 			Article No.				
			8GK9920-0CH32	■	■	■	
Wall-mounting brackets							
			Article No.				
			8GK9920-0CH33	■	■	■	